



The ideal solution for spot lighting

MASTER VALUE LEDspot LV

Philips MASTER VALUE MR16 is the series of Low Voltage (12VAC) Halogen MR16 replacements. Not only does it employ Philips' patented solution to guarantee the broadest possible compatibility with standard 12V Halogen electronic transformers. It also delivers beam intensity which is equivalent to the 50W Philips Halogen MR16 lamps. The form-factor of Philips MASTER Value LED MR16 guarantees a 100% form on the back-side of the lamp (exact form with Halogen lamps.)

Benefits

- Up to 80% energy saving compared with halogen lamp
- Broad compatibility with transformers
- Retrofittable with low-voltage MR16 halogen lamps with GU5.3 socket

Features

- Dimmable range
- Patented intelligent driver
- Air movement mechanism (active fan cooling) with very low sound levels
- Lifetime of 25,000
- No UV and Cool Beam (no IR), making suitable for illuminating heat-sensitive objects (food, organic materials, paintings etc.)

Application

- Ideal for accent lighting in hotels, hospitals, shops and museums (e.g. floors, elevators, displays)

Warnings and Safety

- Operating temperature range is between -20° C and 45° C ambient
- Only to apply in dry or damp locations and most of open fixtures with lamp-holders that offer sufficient space (10 mm free air space)
- Not intended for use with emergency light fixtures or exit lights

MASTER VALUE LEDspot LV

Versions



GU4 MR11



GU5.3 MR16



GU5.3 MR16



GU5.3 MR16



GU5.3 MR16



LEDspot GU5.3 MR16



GU5.3 2inch/50mm

MASTER VALUE LEDspot LV

Dimensional drawing

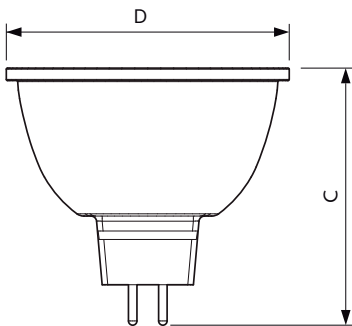
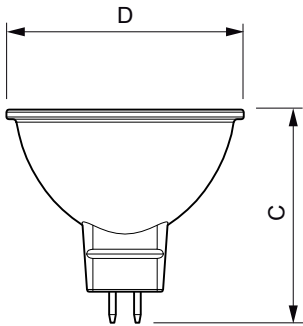
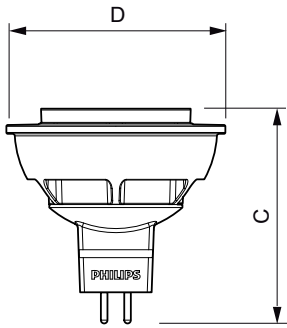
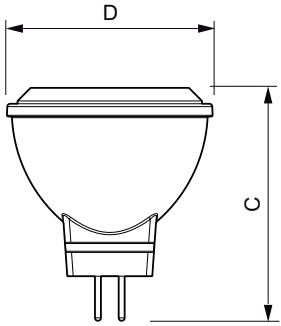

Product	D	C
MAS LEDspotLV 3.5-20W 827 MR11 24D	35 mm	40 mm

Product	D	C
MAS LEDspotLV DimTone 6.5-35W MR16 24D	51 mm	50 mm
MAS LEDspotLV DimTone 6.5-35W MR16 36D	51 mm	50 mm
MASTER LED 4-35W 2700K MR16 24D	50 mm	49 mm
MASTER LED 4-35W 2700K MR16 36D	50 mm	49 mm
MASTER LED 4-35W 3000K MR16 24D	50 mm	49 mm
MASTER LED 4-35W 3000K MR16 36D	50 mm	49 mm
MASTER LED 5.5-50W 2700K MR16 24D CN	50.2 mm	49 mm
MASTER LED 5.5-50W 3000K MR16 36D	50.2 mm	49 mm
MASTER LED 5.5-50W 4000K MR16 24D	50.2 mm	49 mm
MASTER LED 5.5-50W 2700K MR16 36D	50.2 mm	49 mm
MASTER LED 5.5-50W 2700K MR16 24D	50.2 mm	49 mm
MASTER LED 5.5-50W 4000K MR16 36D	50.2 mm	49 mm
MASTER LED 5.5-50W 3000K MR16 24D	50.2 mm	49 mm

Product	D	C
MAS LED spot VLE D 5.5-35W MR16 827 36D	50.5 mm	45 mm
MAS LED spot VLE D 5.5-35W MR16 840 36D	50.5 mm	45 mm
MAS LED spot VLE D 5.5-35W MR16 840 60D	50.5 mm	45 mm
MAS LED spot VLE D 5.5-35W MR16 830 36D	50.5 mm	45 mm
MAS LED spot VLE D 5.5-35W MR16 827 60D	50.5 mm	45 mm
MAS LED spot VLE D 5.5-35W MR16 830 60D	50.5 mm	45 mm

Product	D	C
MAS LED SPOT VLE D 7-50W MR16 840 36D	50.5 mm	45 mm
MAS LEDspotLV DimTone 5-35W MR16 36D	50.5 mm	44.5 mm
MAS LED SPOT VLE D 7-50W MR16 827 36D	50.5 mm	45 mm
MAS LED SPOT VLE D 7-50W MR16 827 60D	50.5 mm	45 mm
MAS LED SPOT VLE D 7-50W MR16 830 36D	50.5 mm	45 mm
MAS LED SPOT VLE D 7-50W MR16 830 60D	50.5 mm	45 mm
MAS LED SPOT VLE D 7-50W MR16 840 60D	50.5 mm	45 mm

MASTER VALUE LEDspot LV

Dimensional drawing

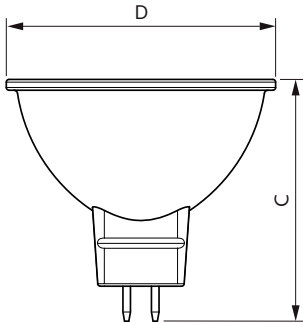

Product	D	C
MAS LEDspotLV DimTone 7-50W MR16 36D	50.5 mm	45.5 mm

Operating and Electrical

Starting Time (Nom)	0.5 s
---------------------	-------

General Information

Switching Cycle	50000X
-----------------	--------

Light Technical

Color Rendering Index (Nom)	80
Llmf At End Of Nominal Lifetime (Nom)	70 %

Approval and Application

Order Code	Full Product Name	Energy Consumption kWh/1000 h	Energy Efficiency Label (EEL)
929001123802	MAS LEDspotLV 3.5-20W 827 MR11 24D	4 kWh	A+
929001127802	MAS LEDspotLV DimTone 6.5-35W MR16 24D	7 kWh	A
929001127902	MAS LEDspotLV DimTone 6.5-35W MR16 36D	7 kWh	A
929001145908	MASTER LED 5.5-50W 2700K MR16 24D	-	-
929001145910	MASTER LED 5.5-50W 2700K MR16 24D CN	-	-
929001146108	MASTER LED 5.5-50W 2700K MR16 36D	-	-
929001146608	MASTER LED 5.5-50W 3000K MR16 36D	-	-
929001146708	MASTER LED 5.5-50W 3000K MR16 24D	-	-
929001146808	MASTER LED 5.5-50W 4000K MR16 24D	-	-
929001146908	MASTER LED 5.5-50W 4000K MR16 36D	-	-
929001147408	MASTER LED 4-35W 2700K MR16 24D	4 kWh	A+

Order Code	Full Product Name	Energy Consumption kWh/1000 h	Energy Efficiency Label (EEL)
929001147508	MASTER LED 4-35W 2700K MR16 36D	4 kWh	A+
929001147608	MASTER LED 4-35W 3000K MR16 36D	4 kWh	A+
929001147708	MASTER LED 4-35W 3000K MR16 24D	4 kWh	A+
929001325902	MAS LED spot VLE D 5.5-35W MR16 827 36D	7 kWh	A+
929001326002	MAS LED spot VLE D 5.5-35W MR16 830 36D	7 kWh	A+
929001326102	MAS LED spot VLE D 5.5-35W MR16 840 36D	7 kWh	A+
929001326202	MAS LED spot VLE D 5.5-35W MR16 827 60D	7 kWh	A+
929001326302	MAS LED spot VLE D 5.5-35W MR16 830 60D	7 kWh	A+
929001326402	MAS LED spot VLE D 5.5-35W MR16 840 60D	7 kWh	A+
929001903402	MAS LED SPOT VLE D 7-50W MR16 827 36D	8 kWh	A+
929001903502	MAS LED SPOT VLE D 7-50W MR16 830 36D	8 kWh	A+

MASTER VALUE LEDspot LV

Order Code	Full Product Name	Energy Consumption kWh/1000 h	Energy Efficiency Label (EEL)
929001903602	MAS LED SPOT VLE D 7-50W MR16 840 36D	8 kWh	A+
929001903702	MAS LED SPOT VLE D 7-50W MR16 827 60D	8 kWh	A+
929001903802	MAS LED SPOT VLE D 7-50W MR16 830 60D	8 kWh	A+

Order Code	Full Product Name	Energy Consumption kWh/1000 h	Energy Efficiency Label (EEL)
929001903902	MAS LED SPOT VLE D 7-50W MR16 840 60D	8 kWh	A+
929001904702	MAS LEDspotLV DimTone 5-35W MR16 36D	6 kWh	A+
929002058902	MAS LEDspotLV DimTone 7-50W MR16 36D	8 kWh	A+

Controls and Dimming

Order Code	Full Product Name	Dimmable
929001123802	MAS LEDspotLV 3.5-20W 827 MR11 24D	No
929001127802	MAS LEDspotLV DimTone 6.5-35W MR16 24D	Yes
929001127902	MAS LEDspotLV DimTone 6.5-35W MR16 36D	Yes
929001145908	MASTER LED 5.5-50W 2700K MR16 24D	No
929001145910	MASTER LED 5.5-50W 2700K MR16 24D CN	No
929001146108	MASTER LED 5.5-50W 2700K MR16 36D	No
929001146608	MASTER LED 5.5-50W 3000K MR16 36D	No
929001146708	MASTER LED 5.5-50W 3000K MR16 24D	No
929001146808	MASTER LED 5.5-50W 4000K MR16 24D	No
929001146908	MASTER LED 5.5-50W 4000K MR16 36D	No
929001147408	MASTER LED 4-35W 2700K MR16 24D	No
929001147508	MASTER LED 4-35W 2700K MR16 36D	No
929001147608	MASTER LED 4-35W 3000K MR16 36D	No
929001147708	MASTER LED 4-35W 3000K MR16 24D	No

Order Code	Full Product Name	Dimmable
929001325902	MAS LED spot VLE D 5.5-35W MR16 827 36D	Yes
929001326002	MAS LED spot VLE D 5.5-35W MR16 830 36D	Yes
929001326102	MAS LED spot VLE D 5.5-35W MR16 840 36D	Yes
929001326202	MAS LED spot VLE D 5.5-35W MR16 827 60D	Yes
929001326302	MAS LED spot VLE D 5.5-35W MR16 830 60D	Yes
929001326402	MAS LED spot VLE D 5.5-35W MR16 840 60D	Yes
929001903402	MAS LED SPOT VLE D 7-50W MR16 827 36D	Yes
929001903502	MAS LED SPOT VLE D 7-50W MR16 830 36D	Yes
929001903602	MAS LED SPOT VLE D 7-50W MR16 840 36D	Yes
929001903702	MAS LED SPOT VLE D 7-50W MR16 827 60D	Yes
929001903802	MAS LED SPOT VLE D 7-50W MR16 830 60D	Yes
929001903902	MAS LED SPOT VLE D 7-50W MR16 840 60D	Yes
929001904702	MAS LEDspotLV DimTone 5-35W MR16 36D	Yes
929002058902	MAS LEDspotLV DimTone 7-50W MR16 36D	Yes

Operating and Electrical

Order Code	Full Product Name	Input Frequency	Voltage (Nom)	Wattage Equivalent	Power (Rated) (Nom)
929001123802	MAS LEDspotLV 3.5-20W 827 MR11 24D	50 to 60 Hz	12 V	20 W	3.5 W
929001127802	MAS LEDspotLV DimTone 6.5-35W MR16 24D	50 to 60 Hz	12 V	35 W	6.5 W
929001127902	MAS LEDspotLV DimTone 6.5-35W MR16 36D	50 to 60 Hz	12 V	35 W	6.5 W
929001145908	MASTER LED 5.5-50W 2700K MR16 24D	-	12 V	50 W	5.5 W
929001145910	MASTER LED 5.5-50W 2700K MR16 24D CN	-	12 V	50 W	5.5 W

Order Code	Full Product Name	Input Frequency	Voltage (Nom)	Wattage Equivalent	Power (Rated) (Nom)
929001146108	MASTER LED 5.5-50W 2700K MR16 36D	-	12 V	50 W	5.5 W
929001146608	MASTER LED 5.5-50W 3000K MR16 36D	-	12 V	50 W	5.5 W
929001146708	MASTER LED 5.5-50W 3000K MR16 24D	-	12 V	50 W	5.5 W
929001146808	MASTER LED 5.5-50W 4000K MR16 24D	-	12 V	50 W	5.5 W
929001146908	MASTER LED 5.5-50W 4000K MR16 36D	-	12 V	50 W	5.5 W
929001147408	MASTER LED 4-35W 2700K MR16 24D	-	12 V	35 W	4 W

MASTER VALUE LEDspot LV

Order Code	Full Product Name	Input Frequency	Voltage (Nom)	Wattage Equivalent	Power (Rated) (Nom)
929001147508	MASTER LED 4-35W 2700K MR16 36D	-	12 V	20 W	4 W
929001147608	MASTER LED 4-35W 3000K MR16 36D	-	12 V	35 W	4 W
929001147708	MASTER LED 4-35W 3000K MR16 24D	-	12 V	35 W	3.4 W
929001325902	MAS LED spot VLE D 5.5-35W MR16 827 36D	-	ac Electronic 12 V	35 W	5.5 W
929001326002	MAS LED spot VLE D 5.5-35W MR16 830 36D	-	ac Electronic 12 V	35 W	5.5 W
929001326102	MAS LED spot VLE D 5.5-35W MR16 840 36D	-	ac Electronic 12 V	35 W	5.5 W
929001326202	MAS LED spot VLE D 5.5-35W MR16 827 60D	-	ac Electronic 12 V	35 W	5.5 W
929001326302	MAS LED spot VLE D 5.5-35W MR16 830 60D	-	ac Electronic 12 V	35 W	5.5 W
929001326402	MAS LED spot VLE D 5.5-35W MR16 840 60D	-	ac Electronic 12 V	35 W	5.5 W

Order Code	Full Product Name	Input Frequency	Voltage (Nom)	Wattage Equivalent	Power (Rated) (Nom)
929001903402	MAS LED SPOT VLE D 7-50W MR16 827 36D	-	12 V	50 W	7 W
929001903502	MAS LED SPOT VLE D 7-50W MR16 830 36D	-	12 V	50 W	7 W
929001903602	MAS LED SPOT VLE D 7-50W MR16 840 36D	-	12 V	50 W	7 W
929001903702	MAS LED SPOT VLE D 7-50W MR16 827 60D	-	12 V	50 W	7 W
929001903802	MAS LED SPOT VLE D 7-50W MR16 830 60D	-	12 V	50 W	7 W
929001903902	MAS LED SPOT VLE D 7-50W MR16 840 60D	-	12 V	50 W	7 W
929001904702	MAS LEDspotLV DimTone 5-35W MR16 36D	-	AC Electronic 12 V	35 W	5 W
929002058902	MAS LEDspotLV DimTone 7-50W MR16 36D	-	ac electronic 12 V	50 W	7 W

General Information

Order Code	Full Product Name	Cap-Base	Nominal Lifetime (Nom)	Rated Lifetime (Hours)
929001123802	MAS LEDspotLV 3.5-20W 827 MR11 24D	GU4	40000 h	40000 h
929001127802	MAS LEDspotLV DimTone 6.5-35W MR16 24D	GU5.3	25000 h	25000 h
929001127902	MAS LEDspotLV DimTone 6.5-35W MR16 36D	GU5.3	25000 h	25000 h
929001145908	MASTER LED 5.5-50W 2700K MR16 24D	GU5.3	25000 h	25000 h
929001145910	MASTER LED 5.5-50W 2700K MR16 24D CN	GU5.3	25000 h	25000 h
929001146108	MASTER LED 5.5-50W 2700K MR16 36D	GU5.3	25000 h	25000 h
929001146608	MASTER LED 5.5-50W 3000K MR16 36D	GU5.3	25000 h	25000 h
929001146708	MASTER LED 5.5-50W 3000K MR16 24D	GU5.3	25000 h	25000 h

Order Code	Full Product Name	Cap-Base	Nominal Lifetime (Nom)	Rated Lifetime (Hours)
929001146808	MASTER LED 5.5-50W 4000K MR16 24D	GU5.3	25000 h	25000 h
929001146908	MASTER LED 5.5-50W 4000K MR16 36D	GU5.3	25000 h	25000 h
929001147408	MASTER LED 4-35W 2700K MR16 24D	GU5.3	25000 h	25000 h
929001147508	MASTER LED 4-35W 2700K MR16 36D	GU5.3	25000 h	25000 h
929001147608	MASTER LED 4-35W 3000K MR16 36D	GU5.3	25000 h	25000 h
929001147708	MASTER LED 4-35W 3000K MR16 24D	GU5.3	25000 h	25000 h
929001325902	MAS LED spot VLE D 5.5-35W MR16 827 36D	GU5.3	25000 h	25000 h
929001326002	MAS LED spot VLE D 5.5-35W MR16 830 36D	GU5.3	25000 h	25000 h

MASTER VALUE LEDspot LV

Order Code	Full Product Name	Cap-Base	Nominal Lifetime (Nom)	Rated Lifetime (Hours)	Order Code	Full Product Name	Cap-Base	Nominal Lifetime (Nom)	Rated Lifetime (Hours)
929001326102	MAS LED spot VLE D 5.5-35W MR16 840 36D	GU5.3	25000 h	25000 h	929001903602	MAS LED SPOT VLE D 7-50W MR16 840 36D	GU5.3	25000 h	25000 h
929001326202	MAS LED spot VLE D 5.5-35W MR16 827 60D	GU5.3	25000 h	25000 h	929001903702	MAS LED SPOT VLE D 7-50W MR16 827 60D	GU5.3	25000 h	25000 h
929001326302	MAS LED spot VLE D 5.5-35W MR16 830 60D	GU5.3	25000 h	25000 h	929001903802	MAS LED SPOT VLE D 7-50W MR16 830 60D	GU5.3	25000 h	25000 h
929001326402	MAS LED spot VLE D 5.5-35W MR16 840 60D	GU5.3	25000 h	25000 h	929001903902	MAS LED SPOT VLE D 7-50W MR16 840 60D	GU5.3	25000 h	25000 h
929001903402	MAS LED SPOT VLE D 7-50W MR16 827 36D	GU5.3	25000 h	25000 h	929001904702	MAS LEDspotLV DimTone 5-35W MR16 36D	GU5.3	25000 h	25000 h
929001903502	MAS LED SPOT VLE D 7-50W MR16 830 36D	GU5.3	25000 h	25000 h	929002058902	MAS LEDspotLV DimTone 7-50W MR16 36D	GU5.3	25000 h	25000 h

Light Technical (1/2)

Order Code	Full Product Name	Beam Angle (Nom)	Color Code	Correlated Color Temperature (Nom)	Light Distribution	Luminous Flux (Nom)	Luminous Flux (Rated) (Nom)	Luminous Intensity (Nom)
929001123802	MAS LEDspotLV 3.5-20W 827 MR11 24D	24°	827	2700 K	-	210 lm	210 lm	1000 cd
929001127802	MAS LEDspotLV DimTone 6.5-35W MR16 24D	24°	822-827	2200-2700 K	Medium beam 24°	410 lm	410 lm	1800 cd
929001127902	MAS LEDspotLV DimTone 6.5-35W MR16 36D	36°	822-827	2200-2700 K	Medium beam 36°	410 lm	410 lm	900 cd
929001145908	MASTER LED 5.5-50W 2700K MR16 24D	24°	827	2700 K	-	415 lm	415 lm	1800 cd
929001145910	MASTER LED 5.5-50W 2700K MR16 24D CN	24°	827	2700 K	-	415 lm	415 lm	1800 cd
929001146108	MASTER LED 5.5-50W 2700K MR16 36D	36°	827	2700 K	-	415 lm	415 lm	1000 cd
929001146608	MASTER LED 5.5-50W 3000K MR16 36D	36°	830	3000 K	-	425 lm	425 lm	1000 cd
929001146708	MASTER LED 5.5-50W 3000K MR16 24D	24°	830	3000 K	-	425 lm	425 lm	1800 cd
929001146808	MASTER LED 5.5-50W 4000K MR16 24D	24°	840	4000 K	-	450 lm	450 lm	1800 cd
929001146908	MASTER LED 5.5-50W 4000K MR16 36D	36°	840	4000 K	-	450 lm	450 lm	1000 cd
929001147408	MASTER LED 4-35W 2700K MR16 24D	24°	827	2700 K	Medium beam 24°	240 lm	240 lm	1000 cd
929001147508	MASTER LED 4-35W 2700K MR16 36D	36°	827	2700 K	Medium beam 36°	240 lm	240 lm	550 cd
929001147608	MASTER LED 4-35W 3000K MR16 36D	36°	830	3000 K	Medium beam 36°	240 lm	240 lm	600 cd
929001147708	MASTER LED 4-35W 3000K MR16 24D	24°	830	3000 K	Medium beam 24°	240 lm	240 lm	1000 cd
929001325902	MAS LED spot VLE D 5.5-35W MR16 827 36D	36°	827	2700 K	-	450 lm	450 lm	1000 cd
929001326002	MAS LED spot VLE D 5.5-35W MR16 830 36D	36°	830	3000 K	-	460 lm	460 lm	1000 cd

MASTER VALUE LEDspot LV

Order Code	Full Product Name	Beam Angle (Nom)	Color Code	Correlated Color Temperature (Nom)	Light Distribution	Luminous Flux (Nom)	Luminous Flux (Rated) (Nom)	Luminous Intensity (Nom)
929001326102	MAS LED spot VLE D 5.5-35W MR16 840 36D	36 °	840	4000 K	-	490 lm	490 lm	1100 cd
929001326202	MAS LED spot VLE D 5.5-35W MR16 827 60D	60 °	827	2700 K	-	450 lm	450 lm	500 cd
929001326302	MAS LED spot VLE D 5.5-35W MR16 830 60D	60 °	830	3000 K	-	460 lm	460 lm	500 cd
929001326402	MAS LED spot VLE D 5.5-35W MR16 840 60D	60 °	840	4000 K	-	490 lm	490 lm	550 cd
929001903402	MAS LED SPOT VLE D 7-50W MR16 827 36D	36 °	827	2700 K	-	621 lm	621 lm	1500 cd
929001903502	MAS LED SPOT VLE D 7-50W MR16 830 36D	36 °	830	3000 K	-	630 lm	630 lm	1500 cd
929001903602	MAS LED SPOT VLE D 7-50W MR16 840 36D	36 °	840	4000 K	-	660 lm	660 lm	1650 cd
929001903702	MAS LED SPOT VLE D 7-50W MR16 827 60D	60 °	827	2700 K	-	621 lm	621 lm	750 cd
929001903802	MAS LED SPOT VLE D 7-50W MR16 830 60D	60 °	830	3000 K	-	630 lm	630 lm	750 cd
929001903902	MAS LED SPOT VLE D 7-50W MR16 840 60D	60 °	840	4000 K	-	660 lm	660 lm	800 cd
929001904702	MAS LEDspotLV DimTone 5-35W MR16 36D	36 °	822-827	2200-2700 K	-	345 lm	345 lm	600 cd
929002058902	MAS LEDspotLV DimTone 7-50W MR16 36D	36 °	822-827	2200-2700 K	-	621 lm	621 lm	1000 cd

Light Technical (2/2)

Order Code	Full Product Name	Rated Beam Angle	Order Code	Full Product Name	Rated Beam Angle
929001123802	MAS LEDspotLV 3.5-20W 827 MR11 24D	24 °	929001325902	MAS LED spot VLE D 5.5-35W MR16 827 36D	36 °
929001127802	MAS LEDspotLV DimTone 6.5-35W MR16 24D	24 °	929001326002	MAS LED spot VLE D 5.5-35W MR16 830 36D	36 °
929001127902	MAS LEDspotLV DimTone 6.5-35W MR16 36D	36 °	929001326102	MAS LED spot VLE D 5.5-35W MR16 840 36D	36 °
929001145908	MASTER LED 5.5-50W 2700K MR16 24D	24 °	929001326202	MAS LED spot VLE D 5.5-35W MR16 827 60D	60 °
929001145910	MASTER LED 5.5-50W 2700K MR16 24D CN	24 °	929001326302	MAS LED spot VLE D 5.5-35W MR16 830 60D	60 °
929001146108	MASTER LED 5.5-50W 2700K MR16 36D	36 °	929001326402	MAS LED spot VLE D 5.5-35W MR16 840 60D	60 °
929001146608	MASTER LED 5.5-50W 3000K MR16 36D	36 °	929001903402	MAS LED SPOT VLE D 7-50W MR16 827 36D	36 °
929001146708	MASTER LED 5.5-50W 3000K MR16 24D	24 °	929001903502	MAS LED SPOT VLE D 7-50W MR16 830 36D	36 °
929001146808	MASTER LED 5.5-50W 4000K MR16 24D	24 °	929001903602	MAS LED SPOT VLE D 7-50W MR16 840 36D	36 °
929001146908	MASTER LED 5.5-50W 4000K MR16 36D	36 °	929001903702	MAS LED SPOT VLE D 7-50W MR16 827 60D	60 °
929001147408	MASTER LED 4-35W 2700K MR16 24D	24 °	929001903802	MAS LED SPOT VLE D 7-50W MR16 830 60D	60 °
929001147508	MASTER LED 4-35W 2700K MR16 36D	36 °	929001903902	MAS LED SPOT VLE D 7-50W MR16 840 60D	60 °
929001147608	MASTER LED 4-35W 3000K MR16 36D	36 °	929001904702	MAS LEDspotLV DimTone 5-35W MR16 36D	36 °
929001147708	MASTER LED 4-35W 3000K MR16 24D	24 °	929002058902	MAS LEDspotLV DimTone 7-50W MR16 36D	36 °

Mechanical and Housing

Order Code	Full Product Name	Bulb Shape	Order Code	Full Product Name	Bulb Shape
929001123802	MAS LEDspotLV 3.5-20W 827 MR11 24D	MR11	929001145910	MASTER LED 5.5-50W 2700K MR16 24D CN	MR16
929001127802	MAS LEDspotLV DimTone 6.5-35W MR16 24D	MR16	929001146108	MASTER LED 5.5-50W 2700K MR16 36D	MR16
929001127902	MAS LEDspotLV DimTone 6.5-35W MR16 36D	MR16	929001146608	MASTER LED 5.5-50W 3000K MR16 36D	MR16
929001145908	MASTER LED 5.5-50W 2700K MR16 24D	MR16	929001146708	MASTER LED 5.5-50W 3000K MR16 24D	MR16

MASTER VALUE LEDspot LV

Order Code	Full Product Name	Bulb Shape
929001146808	MASTER LED 5.5-50W 4000K MR16 24D	MR16
929001146908	MASTER LED 5.5-50W 4000K MR16 36D	MR16
929001147408	MASTER LED 4-35W 2700K MR16 24D	MR16
929001147508	MASTER LED 4-35W 2700K MR16 36D	MR16
929001147608	MASTER LED 4-35W 3000K MR16 36D	MR16
929001147708	MASTER LED 4-35W 3000K MR16 24D	MR16
929001325902	MAS LED spot VLE D 5.5-35W MR16 827 36D	MR16
929001326002	MAS LED spot VLE D 5.5-35W MR16 830 36D	MR16
929001326102	MAS LED spot VLE D 5.5-35W MR16 840 36D	MR16
929001326202	MAS LED spot VLE D 5.5-35W MR16 827 60D	MR16

Order Code	Full Product Name	Bulb Shape
929001326302	MAS LED spot VLE D 5.5-35W MR16 830 60D	MR16
929001326402	MAS LED spot VLE D 5.5-35W MR16 840 60D	MR16
929001903402	MAS LED SPOT VLE D 7-50W MR16 827 36D	MR16
929001903502	MAS LED SPOT VLE D 7-50W MR16 830 36D	MR16
929001903602	MAS LED SPOT VLE D 7-50W MR16 840 36D	MR16
929001903702	MAS LED SPOT VLE D 7-50W MR16 827 60D	MR16
929001903802	MAS LED SPOT VLE D 7-50W MR16 830 60D	MR16
929001903902	MAS LED SPOT VLE D 7-50W MR16 840 60D	MR16
929001904702	MAS LEDspotLV DimTone 5-35W MR16 36D	MR16
929002058902	MAS LEDspotLV DimTone 7-50W MR16 36D	MR16

Temperature

Order Code	Full Product Name	T-Case Maximum (Nom)
929001123802	MAS LEDspotLV 3.5-20W 827 MR11 24D	94 °C
929001127802	MAS LEDspotLV DimTone 6.5-35W MR16 24D	-
929001127902	MAS LEDspotLV DimTone 6.5-35W MR16 36D	-
929001145908	MASTER LED 5.5-50W 2700K MR16 24D	95 °C
929001145910	MASTER LED 5.5-50W 2700K MR16 24D CN	95 °C
929001146108	MASTER LED 5.5-50W 2700K MR16 36D	95 °C
929001146608	MASTER LED 5.5-50W 3000K MR16 36D	95 °C
929001146708	MASTER LED 5.5-50W 3000K MR16 24D	95 °C
929001146808	MASTER LED 5.5-50W 4000K MR16 24D	95 °C
929001146908	MASTER LED 5.5-50W 4000K MR16 36D	95 °C
929001147408	MASTER LED 4-35W 2700K MR16 24D	65 °C
929001147508	MASTER LED 4-35W 2700K MR16 36D	65 °C
929001147608	MASTER LED 4-35W 3000K MR16 36D	65 °C
929001147708	MASTER LED 4-35W 3000K MR16 24D	65 °C
929001325902	MAS LED spot VLE D 5.5-35W MR16 827 36D	95 °C
929001326002	MAS LED spot VLE D 5.5-35W MR16 830 36D	95 °C
929001326102	MAS LED spot VLE D 5.5-35W MR16 840 36D	95 °C
929001326202	MAS LED spot VLE D 5.5-35W MR16 827 60D	95 °C
929001326302	MAS LED spot VLE D 5.5-35W MR16 830 60D	95 °C
929001326402	MAS LED spot VLE D 5.5-35W MR16 840 60D	95 °C
929001903402	MAS LED SPOT VLE D 7-50W MR16 827 36D	85 °C
929001903502	MAS LED SPOT VLE D 7-50W MR16 830 36D	85 °C
929001903602	MAS LED SPOT VLE D 7-50W MR16 840 36D	85 °C
929001903702	MAS LED SPOT VLE D 7-50W MR16 827 60D	85 °C
929001903802	MAS LED SPOT VLE D 7-50W MR16 830 60D	85 °C
929001903902	MAS LED SPOT VLE D 7-50W MR16 840 60D	85 °C
929001904702	MAS LEDspotLV DimTone 5-35W MR16 36D	70 °C
929002058902	MAS LEDspotLV DimTone 7-50W MR16 36D	86 °C

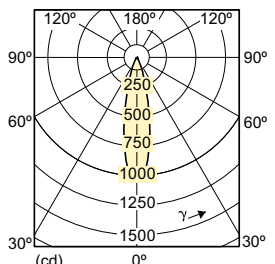
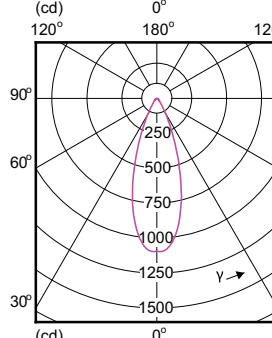
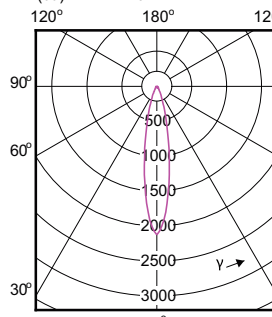
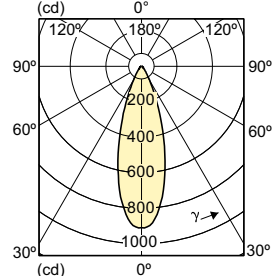
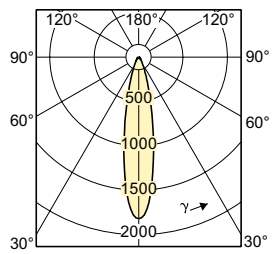

MASTER VALUE LEDspot LV

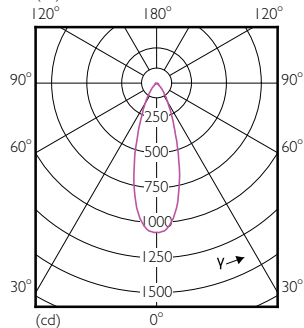
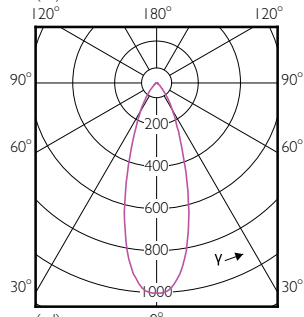
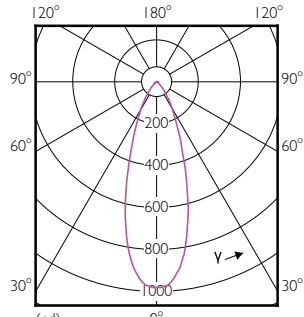
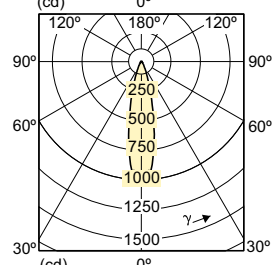
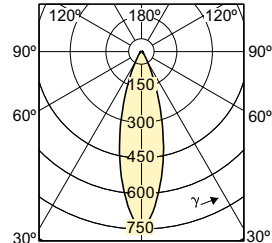
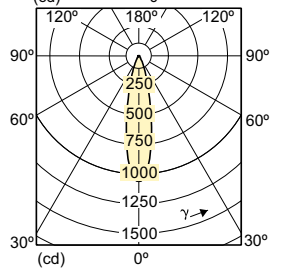
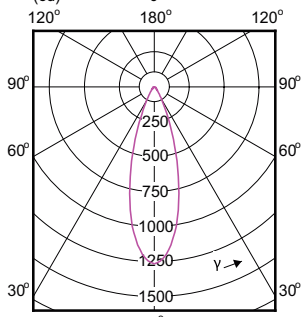
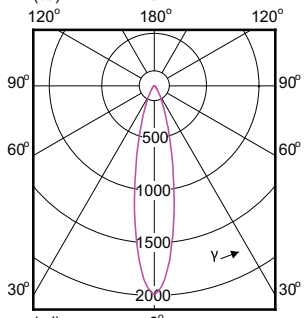
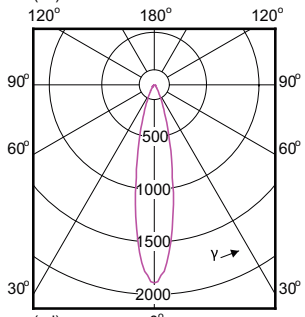
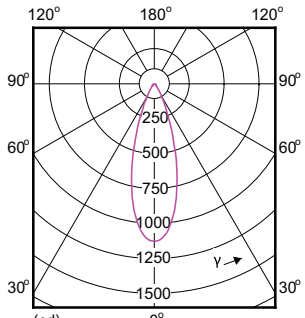

MASTER VALUE LEDspot LV

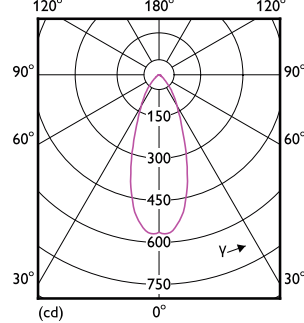
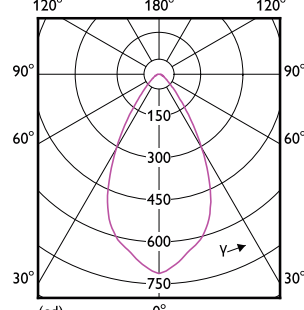
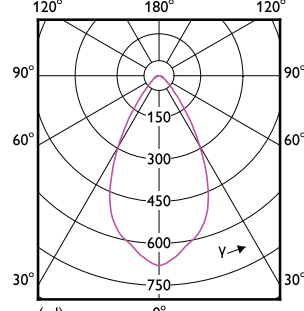
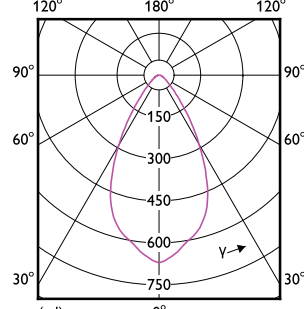
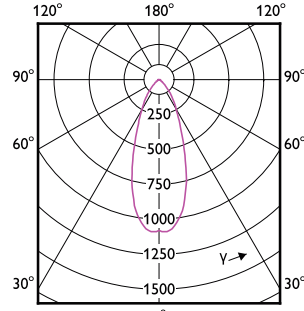
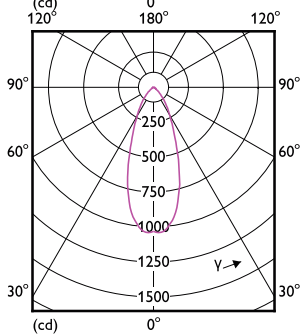
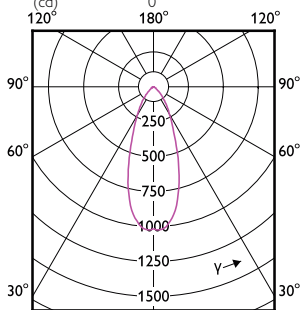
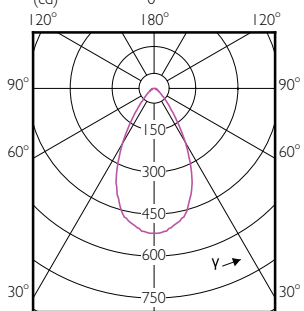
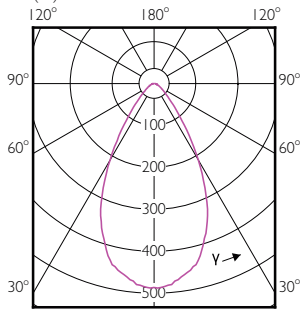
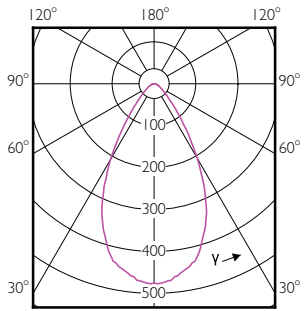

MASTER VALUE LEDspot LV

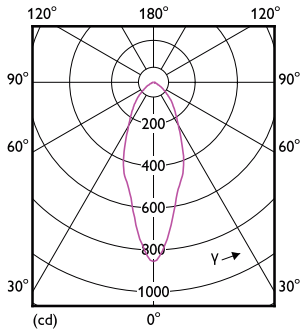

Accent Diagrams

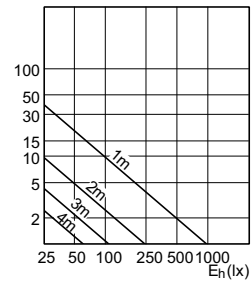
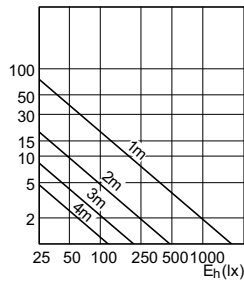
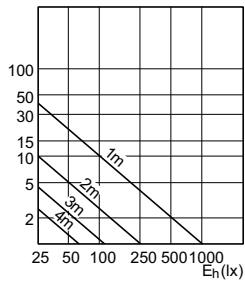

SDAC_LEDspotL_0109-Accent diagram

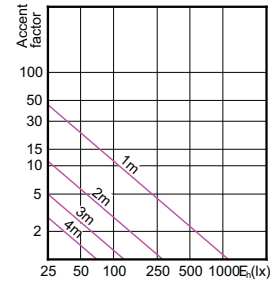
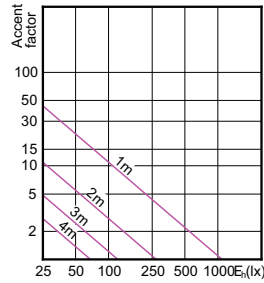
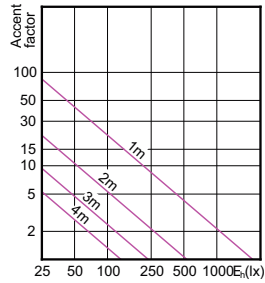

MASTER LED 5.5-50W MR16 GU5.3 2700K
415lm 24D

MASTER LED 5.5-50W MR16 GU5.3 2700K
415lm 36D

MASTER LED 5.5-50W MR16 GU5.3 3000K
425lm 36D

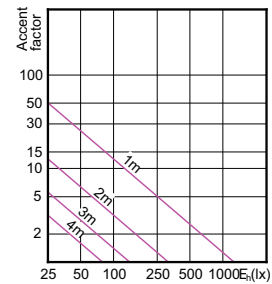
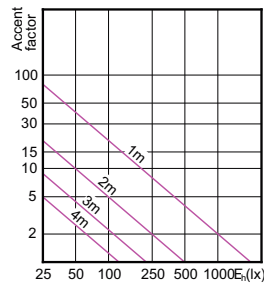
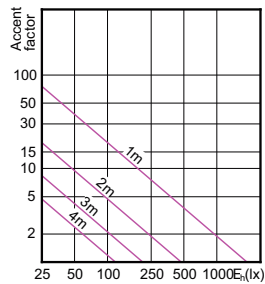

MASTER LED 5.5-50W MR16 GU5.3 3000K
425lm 24D

MASTER LED 5.5-50W MR16 GU5.3 4000K
450lm 24D

MASTER LED 5.5-50W MR16 GU5.3 4000K
450lm 36D

MASTER VALUE LEDspot LV

Accent Diagrams

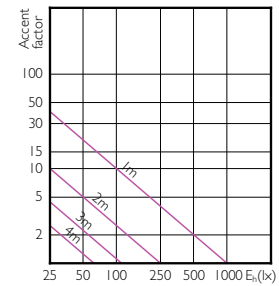
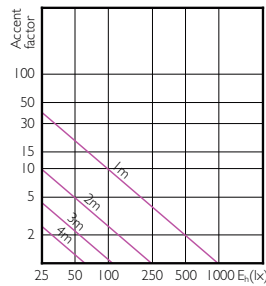
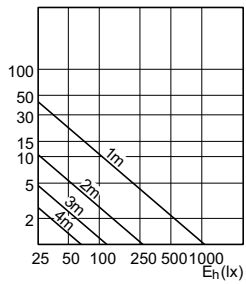
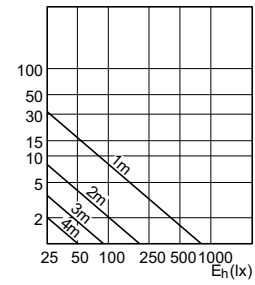
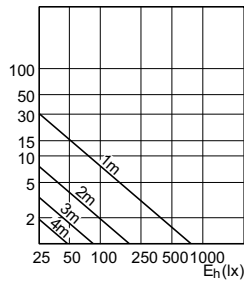
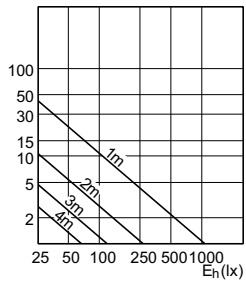

MAS VLE LEDspotLV 35W GU5-3 827 36D MR16

MAS VLE LEDspotLV 35W GU5-3 830 36D MR16

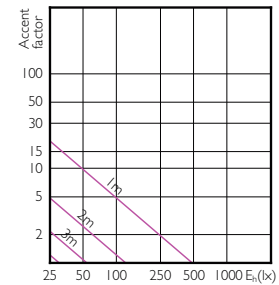
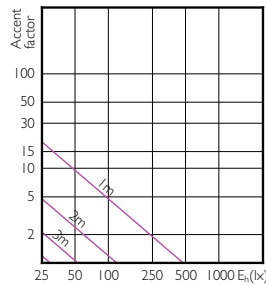
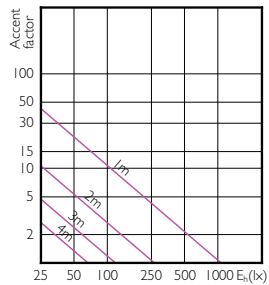

MAS VLE LEDspotLV 35W GU5-3 840 36D MR16

MAS VLE LEDspotLV 35W GU5-3 827 60D MR16

MAS VLE LEDspotLV 35W GU5-3 830 60D MR16

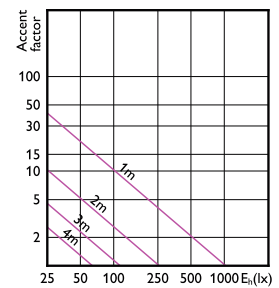
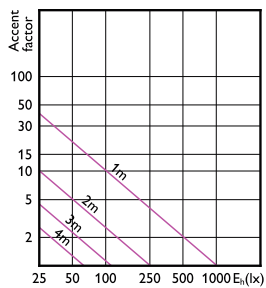
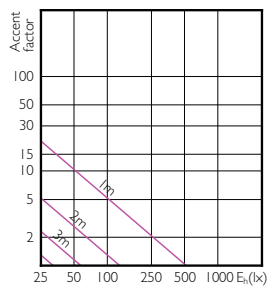

MAS VLE LEDspotLV 35W GU5-3 840 60D MR16

LEDspot MAS VLE 7-50W GU5.3 MR16 827 36D DIM

LEDspot MAS VLE 7-50W GU5.3 MR16 830 36D DIM

MASTER VALUE LEDspot LV

Accent Diagrams

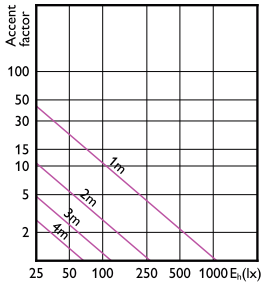

LEDspot MAS VLE 7-50W GU5.3 MR16 840 36D
DIM

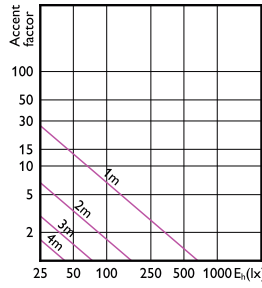

LEDspot MAS VLE 7-50W GU5.3 MR16 827 60D
DIM

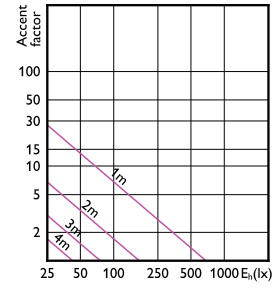

LEDspot MAS VLE 7-50W GU5.3 MR16 830 60D
DIM

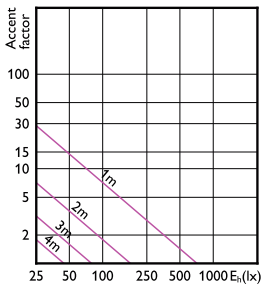

LEDspot MAS VLE 7-50W GU5.3 MR16 840 60D
DIM

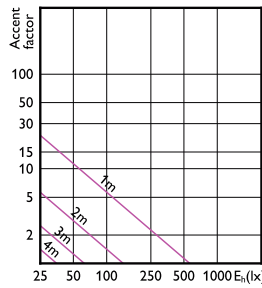

LEDspot MAS 5-35W GU5.3 MR16 822-827 36D
DIM

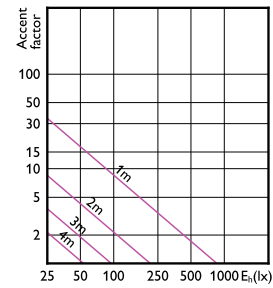

LEDspot MR16 GU5.3

Beam Diagrams

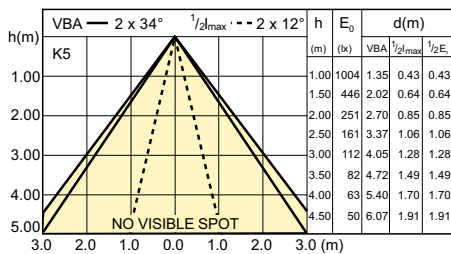

SDBE_LEDspotL_0101-Beam diagram

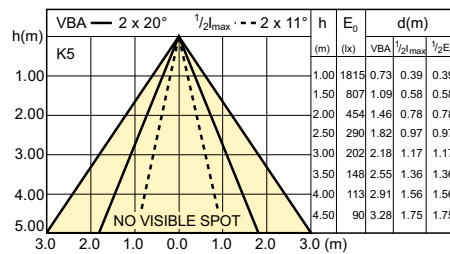

SDBE_LEDspotL_0108-Beam diagram

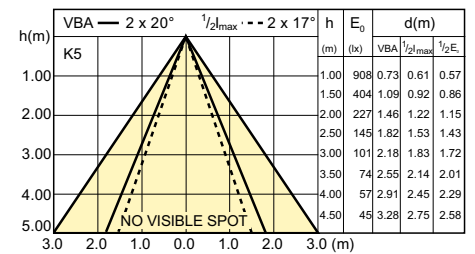

SDBE_LEDspotL_0109-Beam diagram

MASTER VALUE LEDspot LV

Beam Diagrams

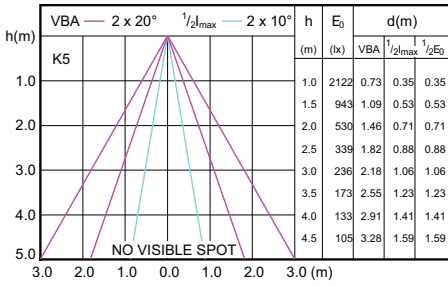

MASTER LED 5.5-50W MR16 GU5.3 2700K
415lm 24D

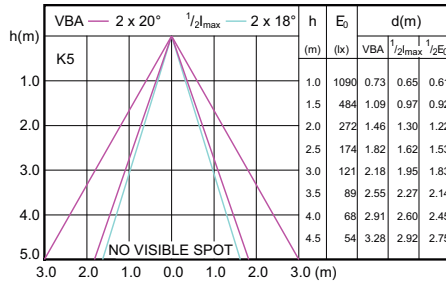

MASTER LED 5.5-50W MR16 GU5.3 2700K
415lm 36D

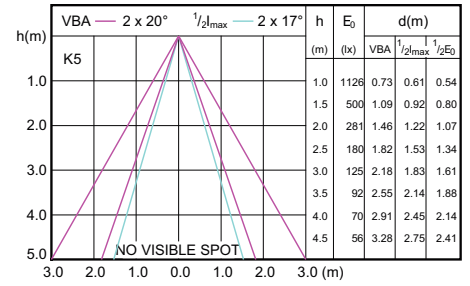

MASTER LED 5.5-50W MR16 GU5.3 3000K
425lm 36D

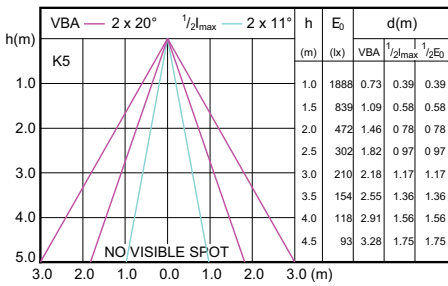

MASTER LED 5.5-50W MR16 GU5.3 3000K
425lm 24D

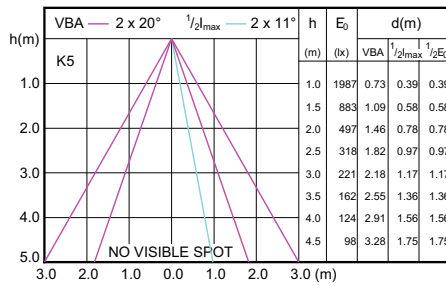

MASTER LED 5.5-50W MR16 GU5.3 4000K
450lm 24D

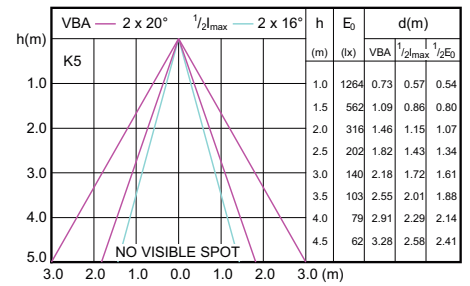

MASTER LED 5.5-50W MR16 GU5.3 4000K
450lm 36D

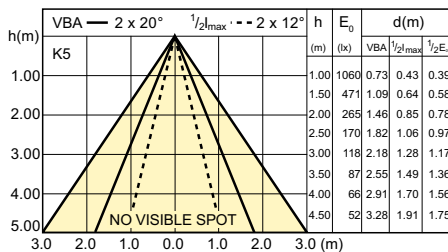

SDBE_LEDspotL_0112-Beam diagram

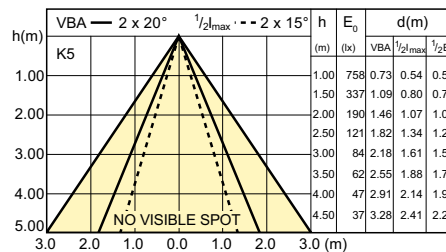

SDBE_LEDspotL_0114-Beam diagram

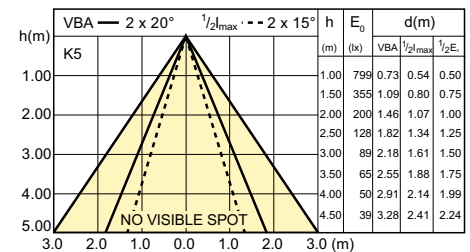

SDBE_LEDspotL_0115-Beam diagram

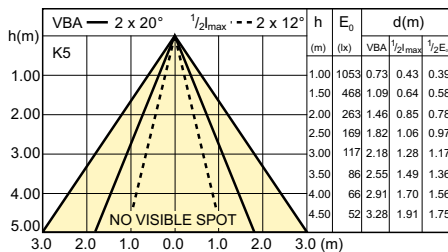

SDBE_LEDspotL_0113-Beam diagram

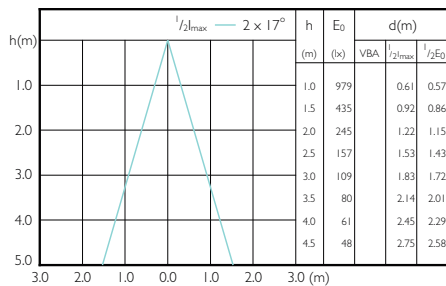

MAS VLE LEDspotLV 35W GU5-3 827 36D MR16

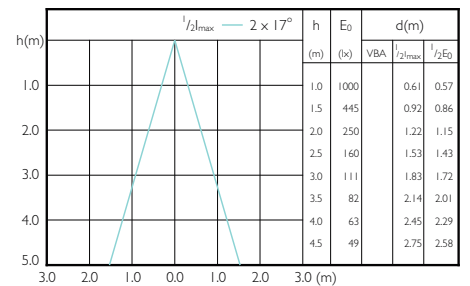

MAS VLE LEDspotLV 35W GU5-3 830 36D MR16

MASTER VALUE LEDspot LV

Beam Diagrams

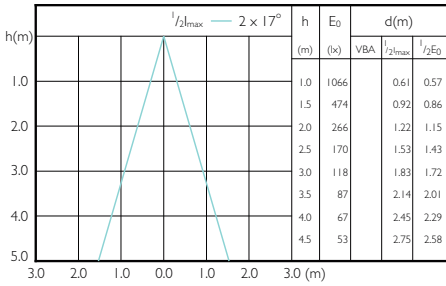

MAS VLE LEDspotLV 35W GU5-3 840 36D MR16

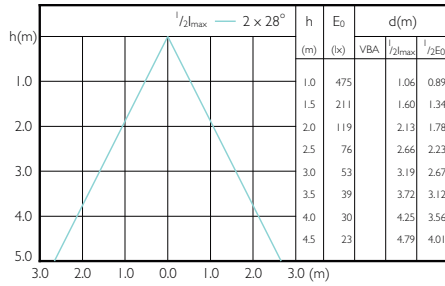

MAS VLE LEDspotLV 35W GU5-3 827 60D MR16

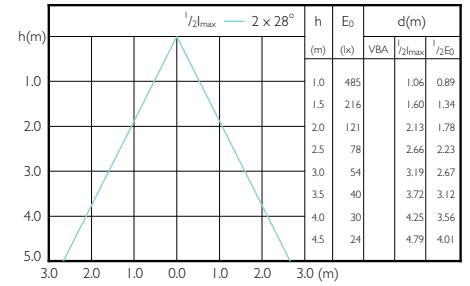

MAS VLE LEDspotLV 35W GU5-3 830 60D MR16

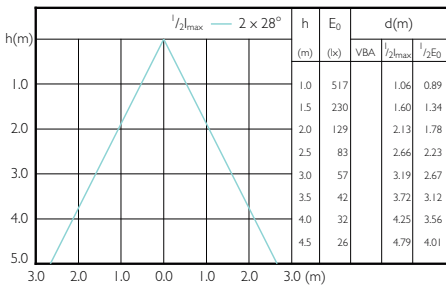

MAS VLE LEDspotLV 35W GU5-3 840 60D MR16

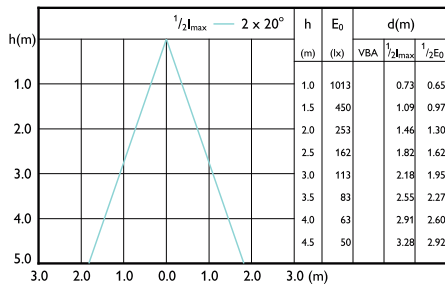

LEDspot MAS VLE 7-50W GU5.3 MR16 827 36D DIM

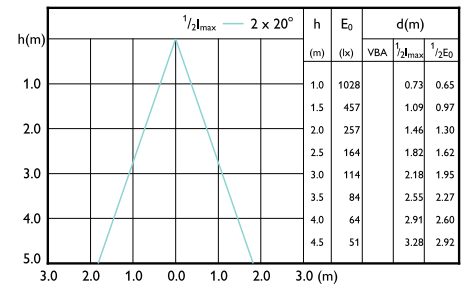

LEDspot MAS VLE 7-50W GU5.3 MR16 830 36D DIM

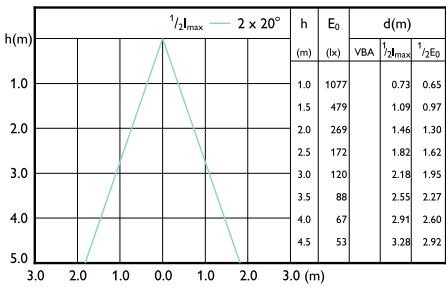

LEDspot MAS VLE 7-50W GU5.3 MR16 840 36D DIM

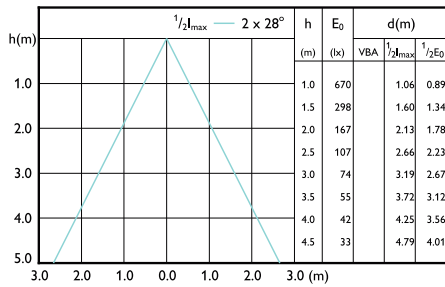

LEDspot MAS VLE 7-50W GU5.3 MR16 827 60D DIM

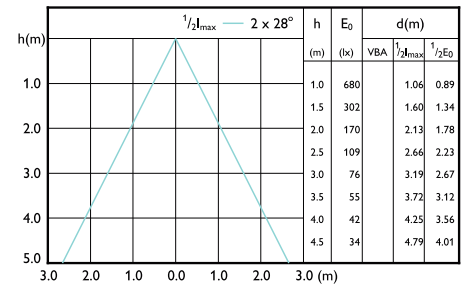

LEDspot MAS VLE 7-50W GU5.3 MR16 830 60D DIM

MASTER VALUE LEDspot LV

Beam Diagrams

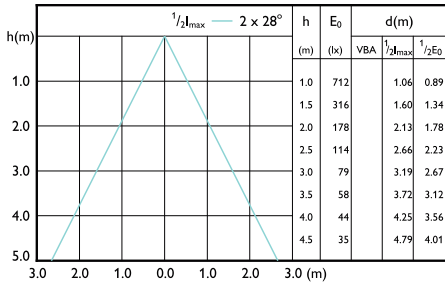

LEDspot MAS VLE 7-50W GU5.3 MR16 840 60D
DIM

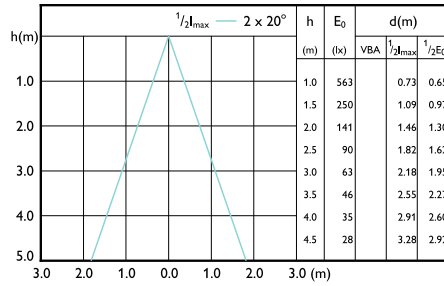

LEDspot MAS 5-35W GU5.3 MR16 822-827 36D
DIM

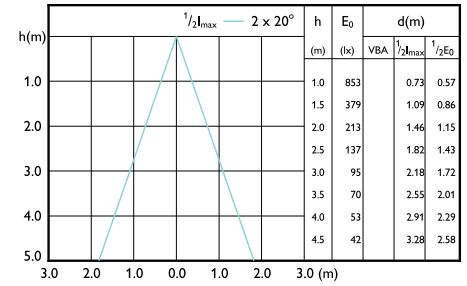

LEDSpot MR16 GU5.3

